

RAYMORE, MO 64083
1-800-821-7137

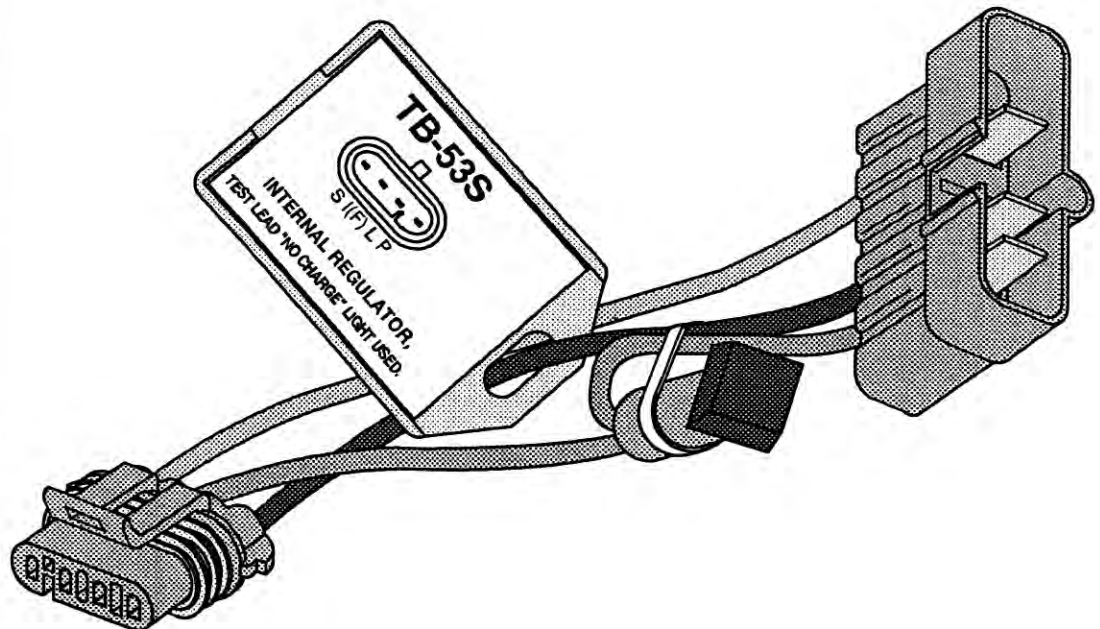

ALTERNATOR TEST LEAD PICTURE GUIDE



Why **JIMCO** test leads?

A test bench without test leads is like pants without pockets - still functional but not very handy!

JIMCO takes pride in its alternator test leads. We use genuine OEM housings where possible, heavy duty wire and permanent I.D. tags. This means they fit what they should, will last, and you can find the one you need.

Another plus, **JIMCO** test leads are the **ONLY** ones called out in the industry approved alternator hook-up manual!

JIMCO, INC.
611 EAST WALNUT
P.O. BOX 137
RAYMORE, MO 64083 USA
PHONE 816-331-1917
800-821-7137
FAX 816-331-1971

Information in this publication was obtained from sources believed to be accurate.
JIMCO, Inc. assumes no responsibility for possible errors.
Permission to reproduce any portion is denied.

COPYRIGHT © 1995 JIMCO, Inc.



Test lead storage rack

PART NO.
T29-4408

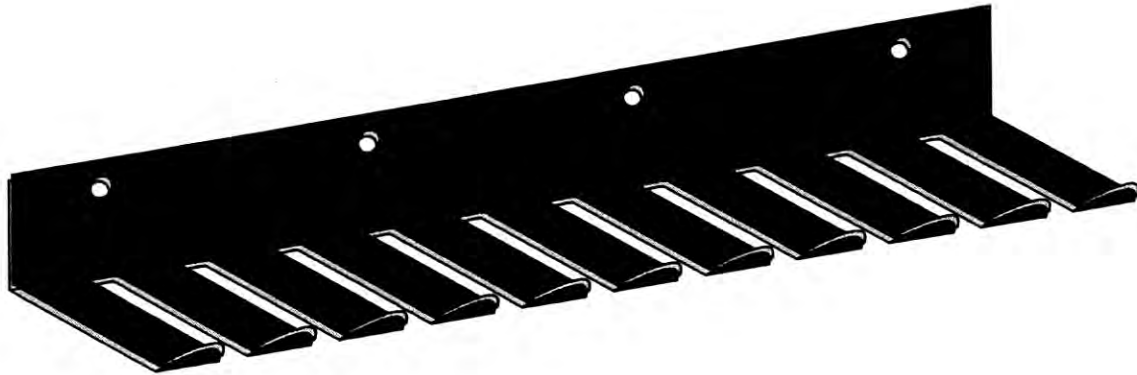

TBTLAC.DRW 04-98, R-2 05-04

Test lead identification tags

Also use to make custom test leads

PART NO.
T95-TBTAG
5 PER BAG

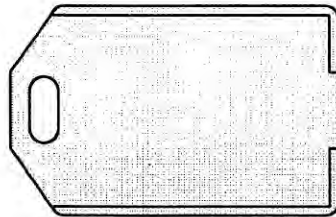

Clear, hard plastic shell with slot for inserting identification information.
1-3/8 X 2-1/8

Test lead "No Charge" Indicator light parts

PART NUMBERS



LENS
RED - T24-30170
GREEN - T24-30174

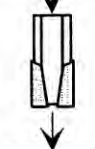

LIGHT BULB
T95-16ESB
5 PER BAG

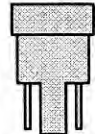

BULB SOCKET
T24-30153

COMPLETE ASSEMBLY

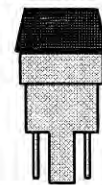

PART NUMBERS
T95-30170AR - RED
T95-30174AG - GREEN

Respective part numbers include:
1 each
Bulb, lens, bulb socket and mounting spring washer

Test lead repair connector

Also use to make custom test leads

PART NO.
T95-539TM
5 PER BAG

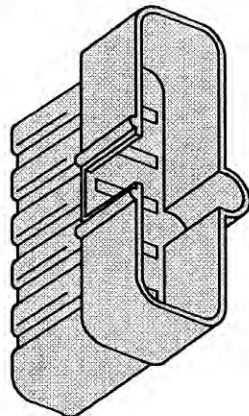

Includes 6 male terminals for each connector housing



Adapter plug harness repair connector

PART NO.
T95-538TF
1 PER BAG

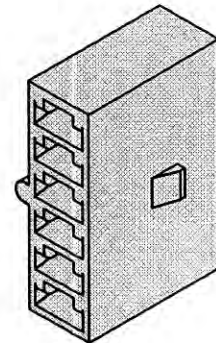

Includes 6 female terminals



"C" (Complex) Test lead replacement plastic box

Replace broken boxes

PART NO.
T95-M4005064

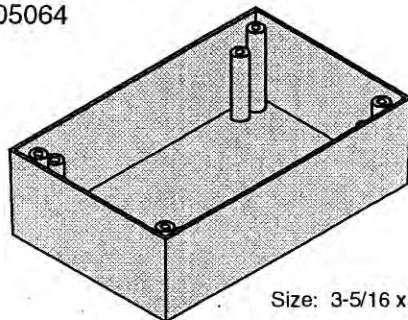

Size: 3-5/16 x 5-1/4

Includes pop rivets

"C" (Complex) Test lead replacement face panels

Replace broken panels

LEAD	PART NOS.
TB-9C	T95-TBI89C
TB-43C	T95-TBI843C
TB-52C	T95-TBI852C
TB-53C	T95-TBI853C
TB-62	T95-TBI862
TB-197	T95-TBI8197

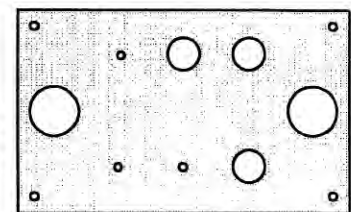

Size: 3-1/8 x 5-1/8

Includes 4 pop rivets, plugs, strain reliefs and applicable label

TBTLAC.DRW 04-08